



1661P01, 1661P02

DESIGO™ RXC

## Gateway EnOcean/LonWorks

## RXZ95.1/LON

For use with:

- DESIGO RXC
- Devices / systems with LONWORKS® communication

- 
- **Wireless receiver with LONWORKS® interface FTT10A**
  - **Evaluation of up to 16 EnOcean room units**
  - **Operating voltage AC / DC 24 V**

### Validity

This data sheet is valid for devices with index B and higher.

For devices with index A see [CM2N1661en\\_02](#).

## Use

---

With the RXC room controllers, wireless room units can be used in place of the QAX3x standard room units. One of the wireless technologies used is EnOcean. Here, the **room unit** is powered by a solar cell. A battery is only needed if light conditions are poor.

The **gateway** requires a separate AC / DC 24 V supply (not in the scope of delivery).

Integration of the EnOcean room units (QAX9x.x) into the system is made via the RXZ95.1/LON EnOcean/LONWORKS gateway. It handles up to 16 EnOcean room units. The telegrams received via radio are converted to LONWORKS standard network variables (SNVT).

## Type summary

---

Product number	Stock number	Designation
RXZ95.1/LON	S55842-Z100	Gateway EnOcean/LONWORKS

An external antenna is included in the delivery.

## Ordering

---

When ordering, please give quantity, designation, product number and stock number.  
When ordering, please give, Product number and Stock number.

*Example:*

**10 Gateways EnOcean/LONWORKS, RXZ95.1/LON, S55842-Z100**

## Equipment combinations

---

EnOcean room units

Product number	Stock number	Designation
QAX95.1	S55623-H100	Wireless and battery-less room unit with EnOcean interface (temperature sensor)
QAX96.1	S55623-H101	Wireless and battery-less room unit with EnOcean interface (temperature sensor with setpoint adjuster)
QAX95.4	S55623-H104	Wireless and battery-less room unit with EnOcean interface (temperature sensor)
QAX96.4	S55623-H105	Wireless and battery-less room unit with EnOcean interface (temperature sensor with setpoint adjuster)
QAX97.4	S55623-H106	Wireless and battery-less room unit with EnOcean interface (temperature sensor with setpoint adjuster, freely programmable button and 2-stage switch)
QAX98.4	S55623-H108	Wireless and battery-less room unit with EnOcean interface (temperature sensor with setpoint adjuster, freely programmable button and 5-stage switch)

Note The RXZ95.1/LON can be used in all systems with LONWORKS communication

## Topology

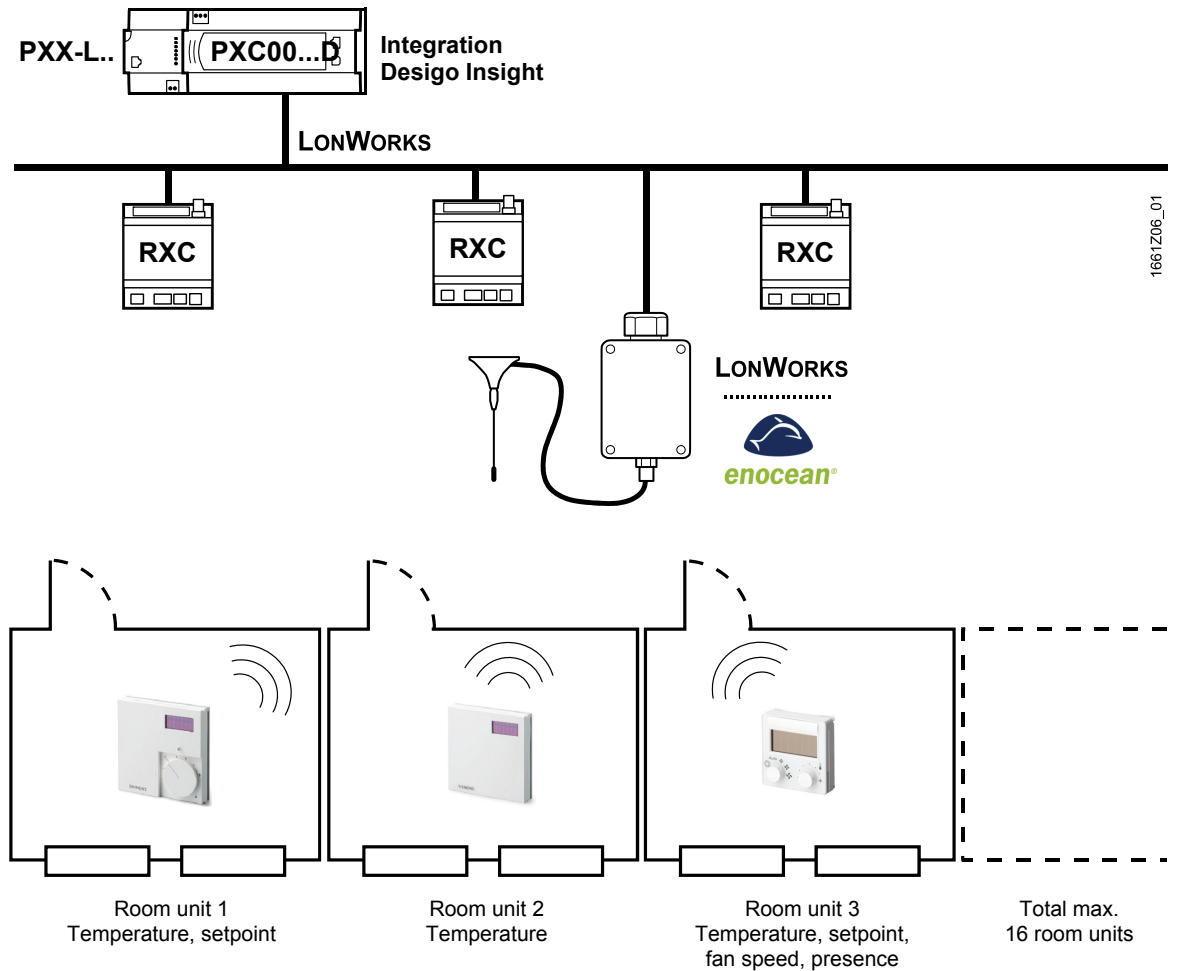

Integration of EnOcean room units into DESIGO RXC

## Mechanical design

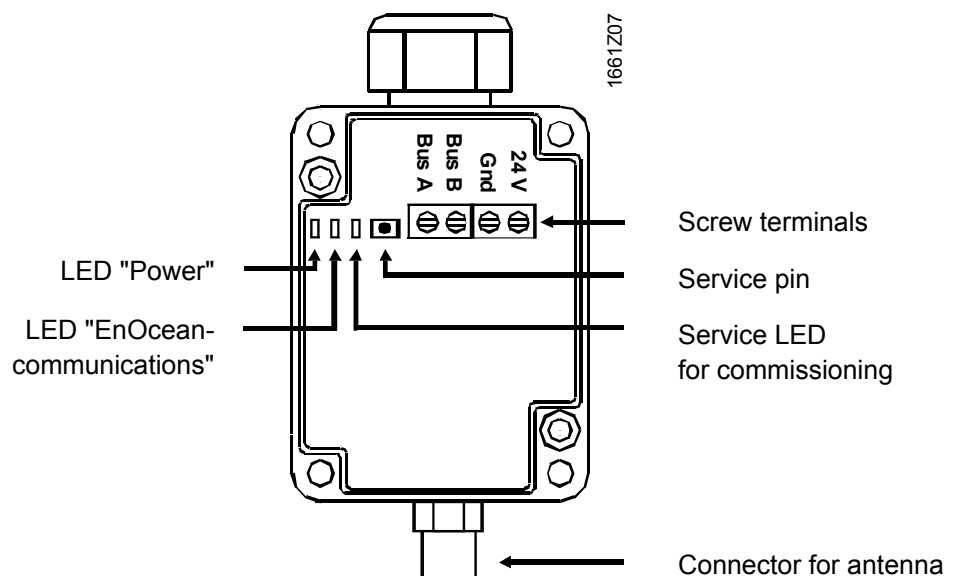

## System requirements

---

<b>Software LNS PlugIn</b>	Thermokon_LNS_PlugIn-FT5000 (Template: srca_16_1_01)  <i>Functions:</i> Monitoring and configuration gateway / room units For use with RXT10 tool or standard LNS tool
<b>Device resource files: Thermokon_DRF24.exe</b>	The device resource files contain information about supplier-specific configuration parameters and network variables (UNVTs and UCTPs).  Prerequisite for installation is LONMARK® resource files version 13.00 or, alternatively, LonMARK resource file API version 2.3 (bothersome installation).
<b>LONWORKS application</b>	srca_16_1_01.XIF; .NXE; .XFB; .XIF; .PDF (if SRC-FTT plug-in is not used)
<b>Software source / documentation</b>	LNS plug-in, device resource files, LONWORKS application: Download from the DESIGO RX intranet: <a href="https://intranet10.sbt.siemens.com/https://intra.industry.siemens.com/bt/global/en/business/building_comfort/systems/desigo/ra/Pages/des-ra-units.aspx?TabcardNo=6">https://intranet10.sbt.siemens.com/https://intra.industry.siemens.com/bt/global/en/business/building_comfort/systems/desigo/ra/Pages/des-ra-units.aspx?TabcardNo=6</a>  LONMARK resource files version 13.00: Download from <a href="http://www.lonmark.org/technical_resources/resource_files/">http://www.lonmark.org/technical_resources/resource_files/</a>  Plug-In: Thermokon LNS Plug-In_1.0.4198.23662_setup.exe

## Environment for engineering tool

---

**Integration of QAX95.x/QAX96.x:** The RXT10 tool or a standard LNS tool can be used.

**Integration of QAX97.x/QAX98.x:** A standard LNS tool must be used.

## Limitations

---

- With a DESIGO system, it is not possible to integrate additional EnOcean products, such as buttons, presence detectors, etc., via the RXZ95.1/LON gateway with the RXT10 tool.  
  
Reason: In the gateway, temperature and setpoint adjustment are available as static network variables. However, additional functions are configured dynamically, and the RXT10 does not support dynamic network interfaces.
- RXT10 does not support the multifunctional button of the QAX97.4 und QAX98.4 room units.
- For technological reasons, the control performance of an RXC... room controller in connection with an EnOcean room unit is inferior to that with a standard QAX3x room unit

**Infrastructure**

- Basis:** PC with DESIGO infrastructure  
RXT10 version 4 or higher
- Note:** The following components must be installed in the order indicated.
- Step 1:** Installation of LONMARK resource files version 13.00 or higher  
**Source:** [http://www.lonmark.org/technical\\_resources/resource\\_files/](http://www.lonmark.org/technical_resources/resource_files/)
- Step 2:** Installation of device resource files:  
**Source:** Download from the DESIGO RX intranet:  
[https://intra.industry.siemens.com/bt/global/en/business/building\\_comfort/systems/desigo/ra/Pages/des-ra-units.aspx?TabcardNo=6](https://intra.industry.siemens.com/bt/global/en/business/building_comfort/systems/desigo/ra/Pages/des-ra-units.aspx?TabcardNo=6)
- Step 3:** Installation of Thermokon plug-in  
**Source:** Download from the DESIGO RX intranet:  
[https://intra.industry.siemens.com/bt/global/en/business/building\\_comfort/systems/desigo/ra/Pages/des-ra-units.aspx?TabcardNo=6](https://intra.industry.siemens.com/bt/global/en/business/building_comfort/systems/desigo/ra/Pages/des-ra-units.aspx?TabcardNo=6)

**Engineering with RXT10 and LNS plug-in**

Set up the gateway with the RXT10 tool by following the standard procedure for integration of third-party devices (for details, refer to User Manual RXT10, CM110669).

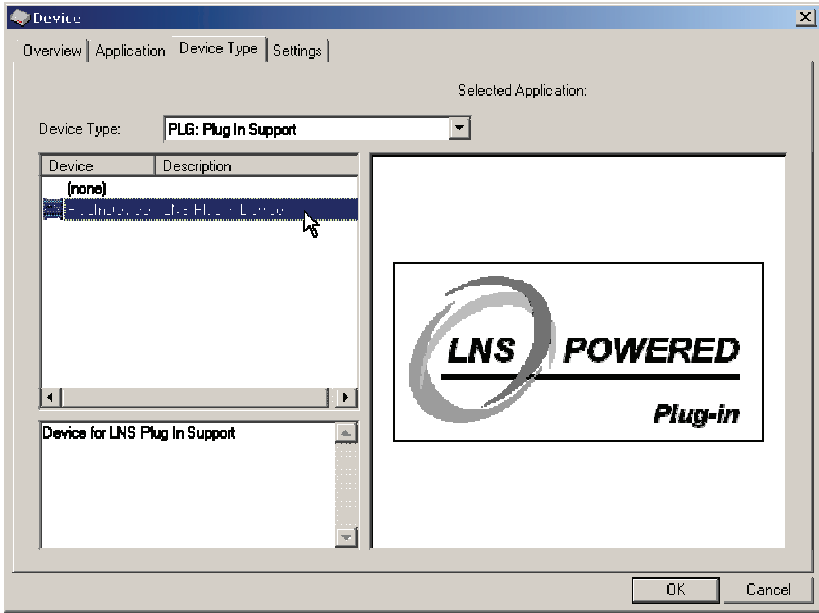
Step	Procedure
1	<p><b>Device &gt; Add</b></p> <p>Select tab <b>Device Type</b>. From menu <b>Device Type</b>, select <b>PLG: Plug In Support</b>. On the "Device" list, highlight <b>PlugInDevice</b>.</p> 
2	<p>Select tab <b>Overview</b> and enter the location. Confirm by clicking <b>OK</b>.</p>

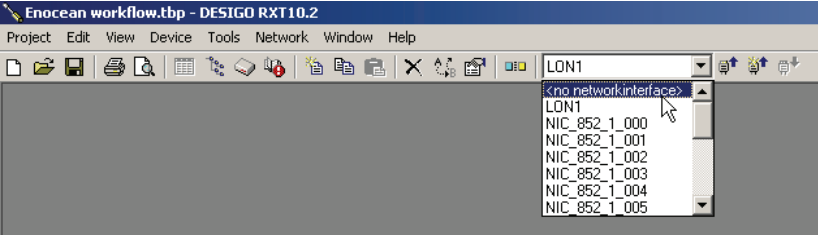
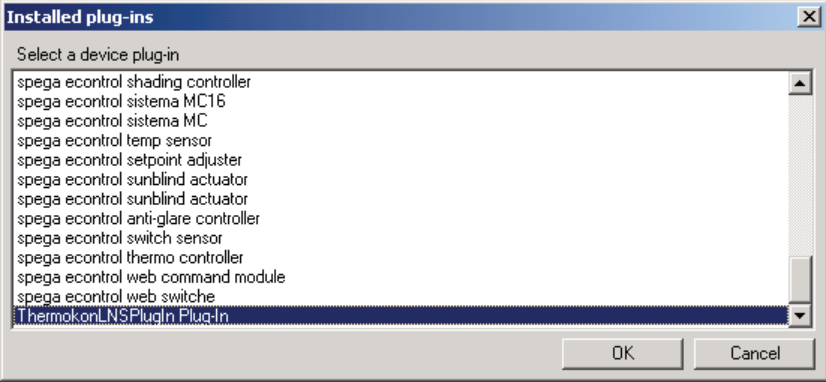
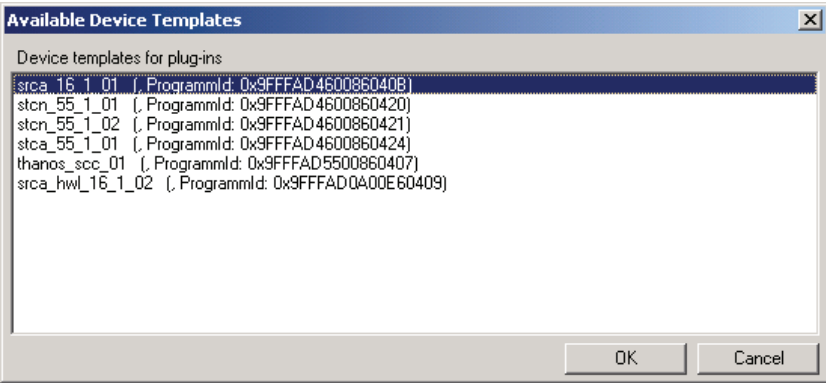
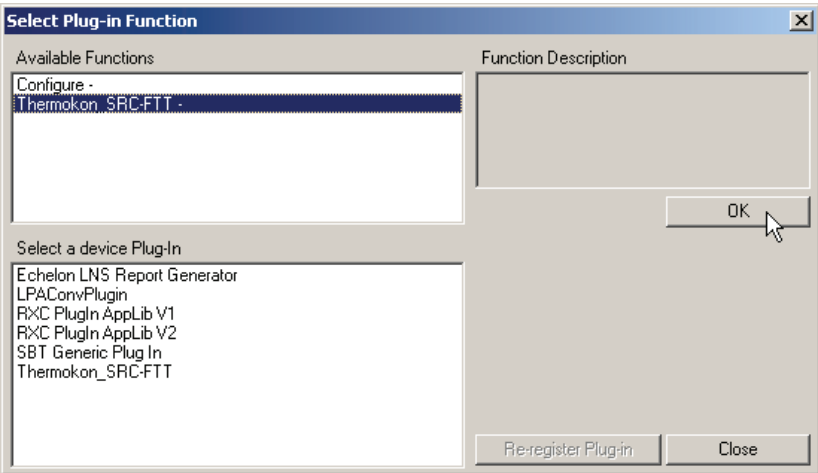
Step	Procedure
3	<p>RXT: Select &lt;no networkinterface&gt;</p>  <p><b>Network &gt; Connect (Attached offnet)</b></p>
4	<p><b>Device &gt; Configure &gt; ThermokonLNSPlugIn.Plug-In &gt; OK</b></p>  <p>Select device template "srca_16_1_01" &gt; OK</p>  <p>Select function "ThermokonLNSPlugIn Device Configuration" &gt; Click <b>OK</b>.</p>  <p>Confirm message by selecting <b>YES</b>.</p>

Step	Procedure
------	-----------

**5a**

Configure the gateway:  
Select tab **General settings**:

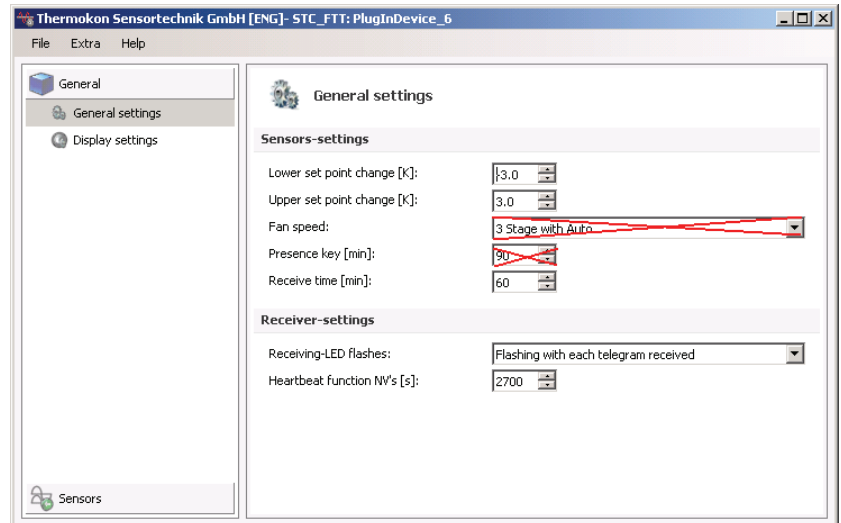

**Receive time:**

Function not available with the RXT10  
For monitoring the RF link to the room unit (optional)

**Sending interval:**



Recommendation: Same as RXC ⇒ Default **2700 [s]** (45 min)

**5b**

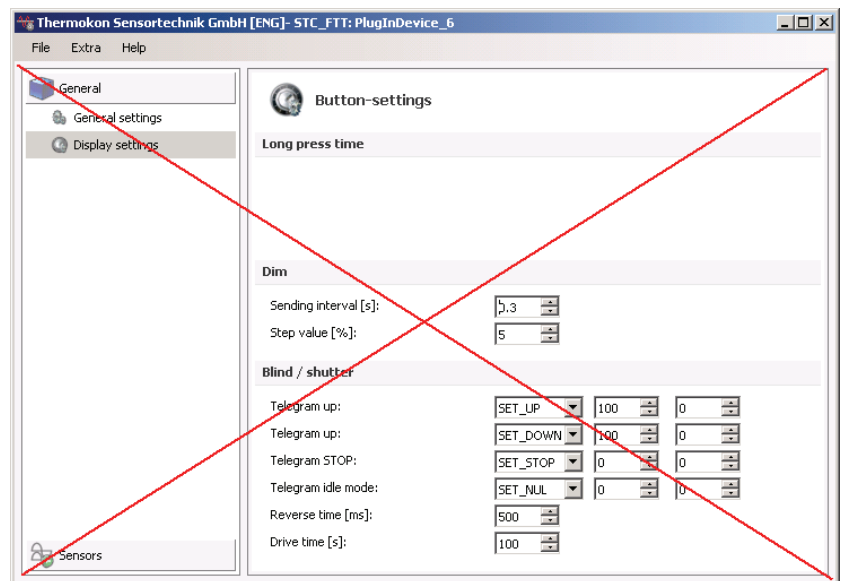
Configure the gateway:  
select tab **Switch settings**:

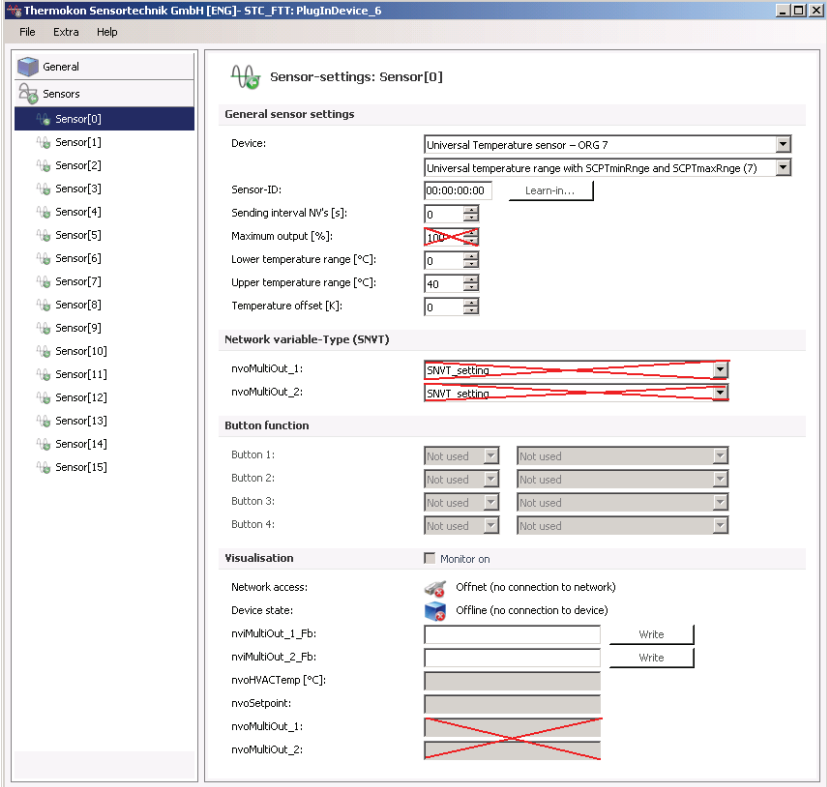

Functions not available with the RXT10

Step	Procedure									
5c	<p>Configure the gateway: select tab <b>Sensor 1...16</b>:</p>  <p> Function not available with the RXT10.</p> <p><b>Device:</b> For room units QAX95.x, QAX96.x, select setting <b>7</b></p> <p><b>SensorID:</b> For offline engineering, the EnOcean ID of the room unit can be entered here, if desired. Normally, it is learned-in online (with connection to the network, see step 10).</p> <p><b>SCPTmaxSendTime:</b> Heartbeat room unit Recommendation: Same as RXC ⇨ Default <b>2700 [s]</b> (45 min)</p> <p><i>Note relating to SCPTmaxSendTime:</i> With the default setting of 0.0 s (OFF) and in the event the RF link breaks down (faults, no light, etc.), the temperature value in the RXC will change to "invalid" when the heartbeat has elapsed. When using a setting greater than 0.0 s, the temperature value received last will be transmitted.</p>									
6	<p>&gt; <b>Apply</b> (Question "...transmit to device?": Answer with <b>YES</b>) <b>Network &gt; Disconnect</b> (Attached offnet)</p>									
7	<p>Make RXT10 bindings:</p> <table border="0"> <thead> <tr> <th data-bbox="603 1809 869 1843"><i><b>Datapoint</b></i></th> <th data-bbox="890 1809 1109 1843"><i><b>Gateway</b></i></th> <th data-bbox="1141 1809 1252 1843"><i><b>RXC</b></i></th> </tr> </thead> <tbody> <tr> <td data-bbox="603 1848 869 1881">Room Temperature:</td> <td data-bbox="890 1848 1109 1881">nvoHVACTemp_x ⇨</td> <td data-bbox="1141 1848 1372 1881">nviSpaceTemp</td> </tr> <tr> <td data-bbox="603 1886 869 1919">Setpoint Offnet:</td> <td data-bbox="890 1886 1109 1919">nvoSetpoint_x ⇨</td> <td data-bbox="1141 1886 1396 1919">nviSetpointOffset</td> </tr> </tbody> </table>	<i><b>Datapoint</b></i>	<i><b>Gateway</b></i>	<i><b>RXC</b></i>	Room Temperature:	nvoHVACTemp_x ⇨	nviSpaceTemp	Setpoint Offnet:	nvoSetpoint_x ⇨	nviSetpointOffset
<i><b>Datapoint</b></i>	<i><b>Gateway</b></i>	<i><b>RXC</b></i>								
Room Temperature:	nvoHVACTemp_x ⇨	nviSpaceTemp								
Setpoint Offnet:	nvoSetpoint_x ⇨	nviSetpointOffset								
8	<p><b>Network &gt; Connect</b> (online)</p>									
9	<p><b>Assign devices and install</b></p>									

Step	Procedure
------	-----------

10

**Learn-in the room units:**

Open Plug-in (**Device > Configure > ThermokonLNSPlugIn Device Configuration > OK > YES**)  
 Click button next to SensorID  
 > **Learn-in** > Press button on the room unit

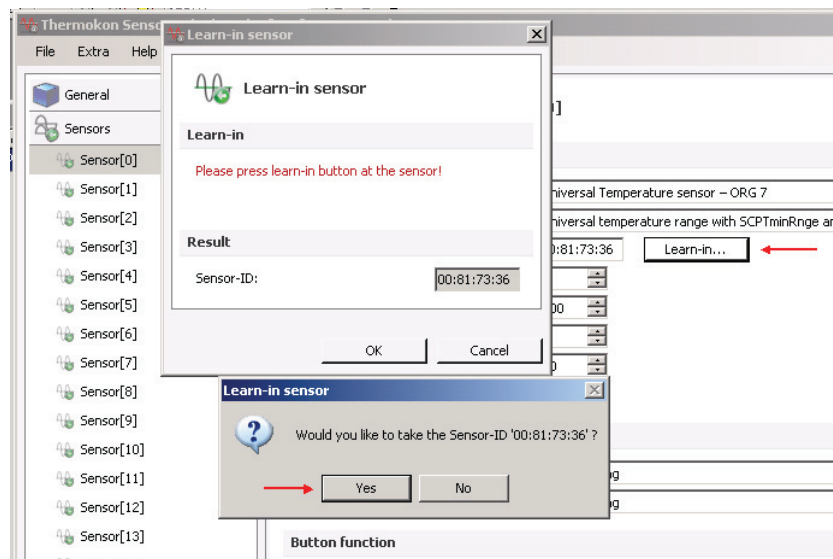

11

**Function check gateway / room unit:**

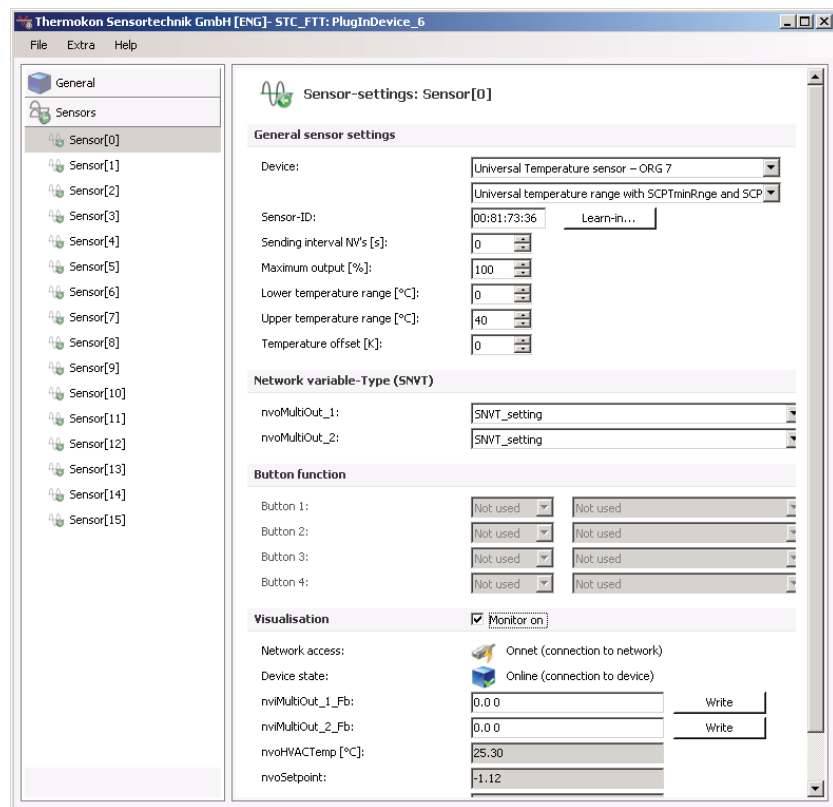

Infrastructure

- Basis: PC with DESIGO infrastructure  
RXT10 version 4 or higher
- Step: *Download:*  
[EasySens SRC-Receiver.zip](#)  
*Extract and save LON application:*  
..\2\_LON-Software\1\_deutsch\EasySens, Funk-Empfangsmodule\SRC04\_SRC65-FTT\srca\_16\_1\_01\srca\_16\_1\_01.XIF (.apb; .nxe; .xfb; .xif)
- Source: Download from the DESIGO RX intranet:  
[https://intra.industry.siemens.com/bt/global/en/business/building\\_comfort/systems/desigo/ra/Pages/des-ra-units.aspx?TabcardNo=6](https://intra.industry.siemens.com/bt/global/en/business/building_comfort/systems/desigo/ra/Pages/des-ra-units.aspx?TabcardNo=6)

Engineering with RXT10 and XIF-Import

Set up the gateway with the RXT10 tool by following the standard procedure for integration of third-party devices (for details, refer to User Manual RXT10, CM110669).

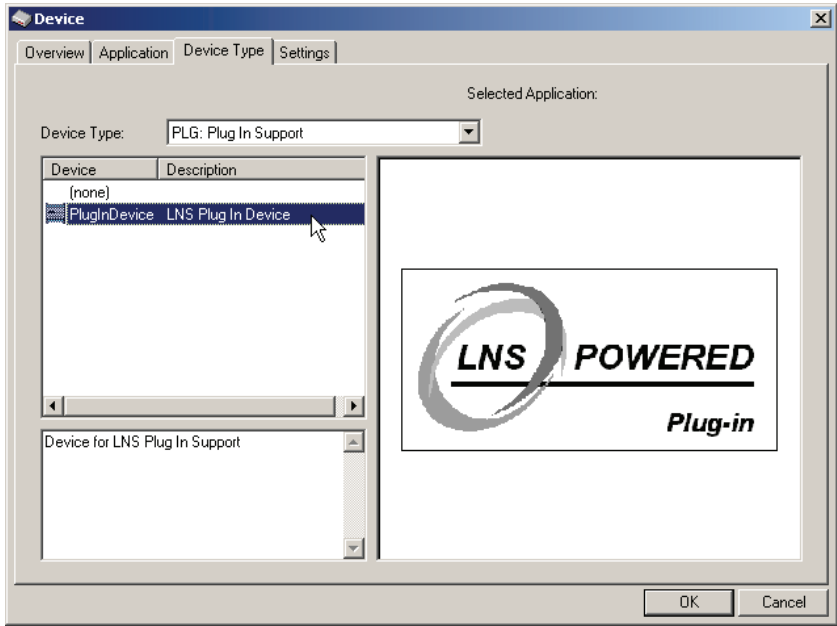
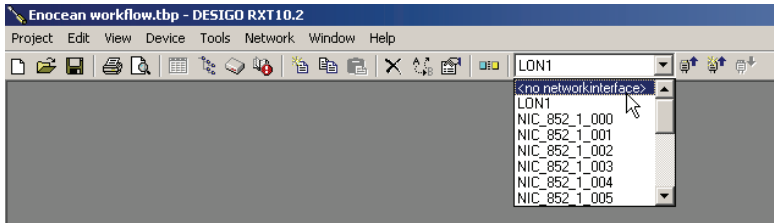
Step	Procedure
1	<p><b>Device &gt; Add</b> Select tab <b>Device Type</b>. From selection menu <b>Device Type</b>, select <b>PLG: Plug In Support</b>. On the "Device" list, highlight <b>PlugInDevice</b>.</p> 
2	Select tab <b>Overview</b> to enter the location. Confirm by clicking <b>OK</b> .
3	<p>RXT: Select <b>&lt;no networkinterface&gt;</b></p>  <p><b>Network &gt; Connect</b> (Attached offnet)</p>

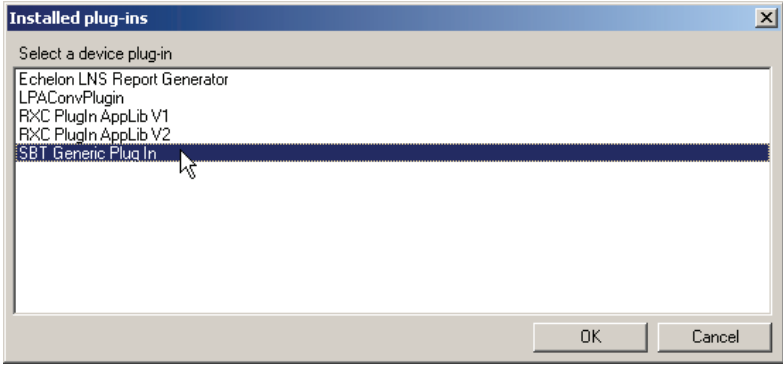
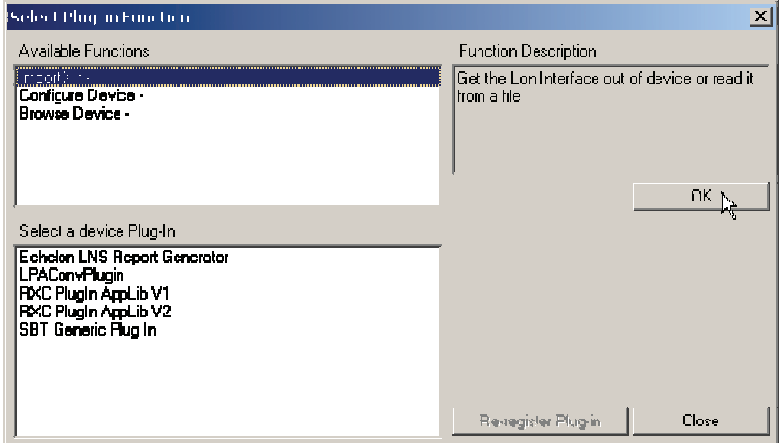
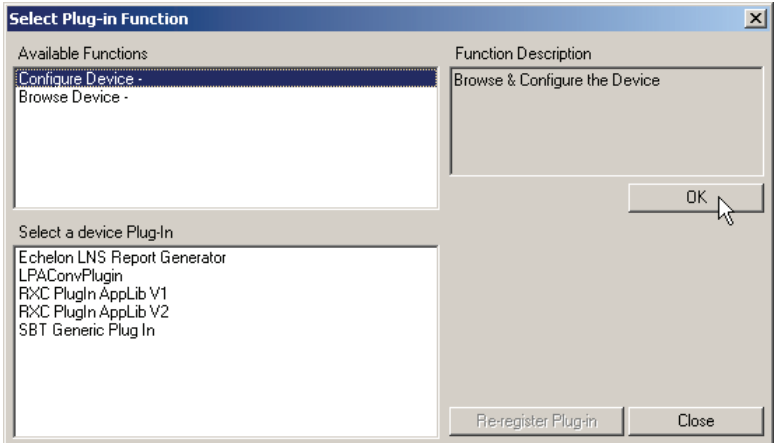
Step	Procedure
4	<p data-bbox="639 152 1246 185"><b>Device &gt; Configure &gt; SBT Generic Plug In &gt; OK</b></p>  <p data-bbox="639 566 1027 600"><b>Select function Import XIF &gt; OK</b></p>  <p data-bbox="639 1061 1337 1095">&gt; <b>Read XIF File &gt; Select path for srca_16_1_01.XIF &gt; OK</b></p> <p data-bbox="639 1106 943 1140">&gt; <b>Select Plug-in &gt; Close</b></p>
5	<p data-bbox="639 1149 1469 1182"><b>Device &gt; Configure &gt; OK (depending on plug-in: Configure Device)</b></p> 

Step	Procedure
------	-----------

**6** Configure the gateway:  
Select **Node Object**

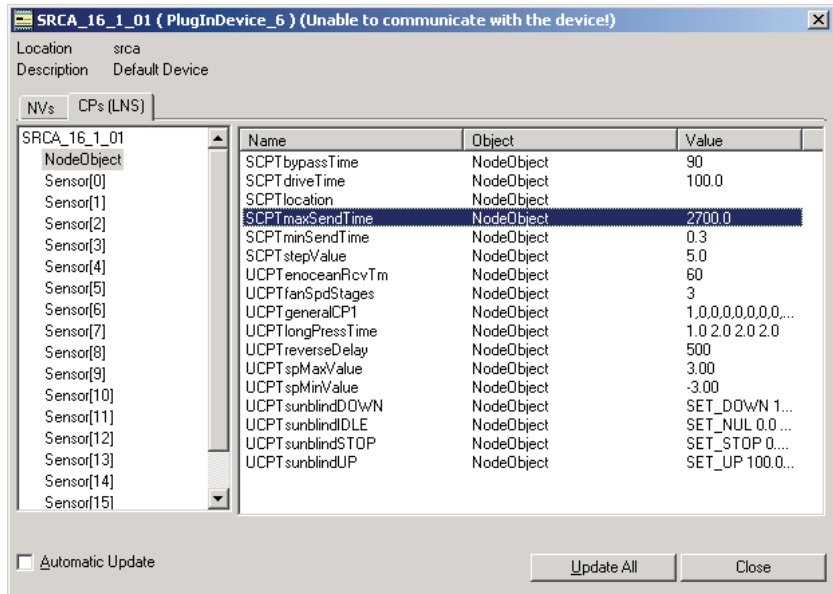

**SCPTmaxSendTime:** Sending interval LONWORKS  
Recommendation: Same as RXC ⇨  
Default **2700 [s]** (45 min)

**UCPTenoceanRcvTm:** Receive time  
For monitoring the RF link to the room unit (optional)

**UCPTspMax/MinValue:** Setpoint Offset (± 3 K, default)

**7** Configure the gateway:  
Select **Sensor Object [0...15]**

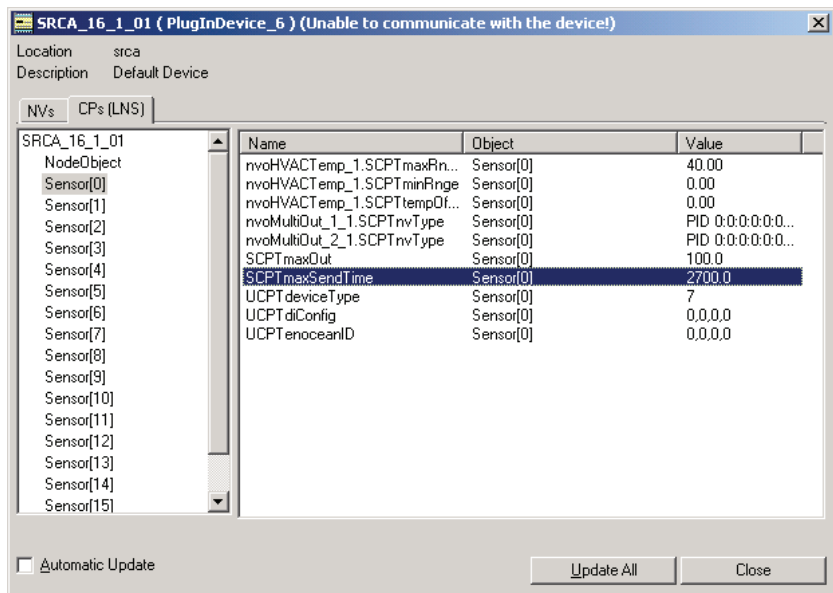

**...SCPTmax/minRnge:** Measuring range of temperature sensor  
[0...40 °C, default]

**SCPTmaxSendTime:** Sending interval LONWORKS  
Recommendation: Same as RXC ⇨  
Default **2700 [s]** (45min)

Step	Procedure									
8	> <b>Close &gt; Active Plug-in finish</b> <b>Network &gt; Disconnect</b> (Attached offnet)									
9	Make RXT10 bindings:  <table border="0"> <tr> <td><b>Datapoint</b></td> <td><b>Gateway</b></td> <td><b>RXC</b></td> </tr> <tr> <td>Room Temperature:</td> <td>nvoHVACTemp_x</td> <td>⇒ nviSpaceTemp</td> </tr> <tr> <td>Setpoint Offnet:</td> <td>nvoSetpoint_x</td> <td>⇒ nviSetpointOffset</td> </tr> </table>	<b>Datapoint</b>	<b>Gateway</b>	<b>RXC</b>	Room Temperature:	nvoHVACTemp_x	⇒ nviSpaceTemp	Setpoint Offnet:	nvoSetpoint_x	⇒ nviSetpointOffset
<b>Datapoint</b>	<b>Gateway</b>	<b>RXC</b>								
Room Temperature:	nvoHVACTemp_x	⇒ nviSpaceTemp								
Setpoint Offnet:	nvoSetpoint_x	⇒ nviSetpointOffset								
10	<b>Netwok &gt; Connect</b> (online)									
11	<b>Assign devices and install</b>									
12	<b>Device &gt; Configure &gt; OK</b>									

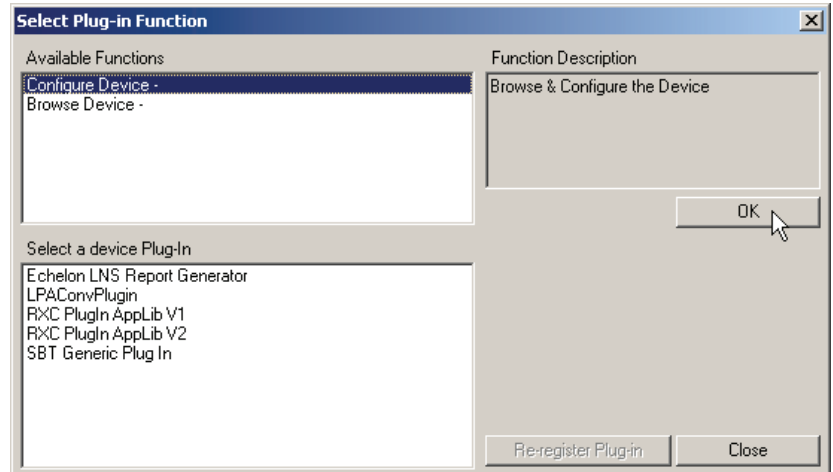

13 Learn-in the room unit:  
**Select Node Object**

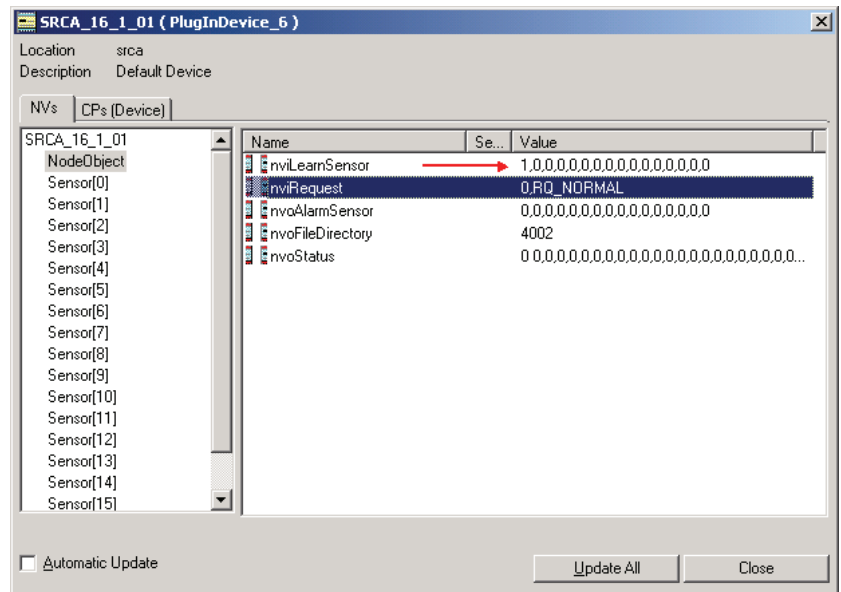



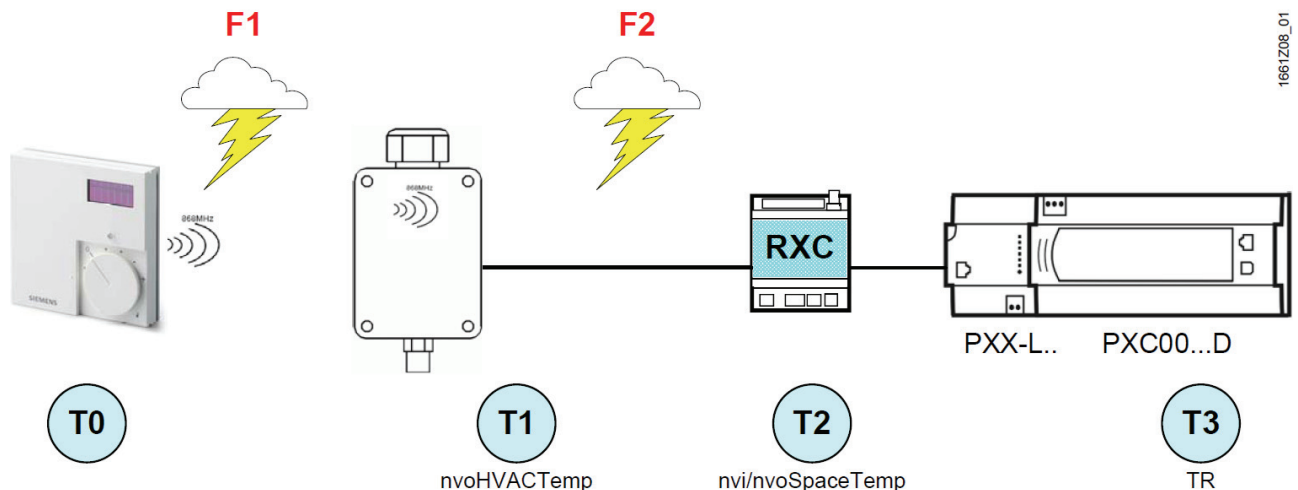

**F1:**  
Gateway receives no telegrams from the room unit

**Possible causes:**

- ⇒ Room unit exhausted ⇒ poor light conditions  
Check documentation on room unit
- ⇒ RF link faulty ⇒ distance, interference emitters  
Check documentation on room unit
- ⇒ Room unit not / incorrectly learned-in in the gateway (SensorID)
- ⇒ Room unit faulty

**Impact on the system:**

When UCPTenoceanRcvTm has elapsed, nvoAlarmSensor is set (evaluation optional).

- T0** --
- T1** Last valid value from T0; otherwise 0.0 °C
- T2** With SCPTmaxSendTime ⇒ T1  
Without SCPTmaxSendTime ⇒ invalid (327.7 °C) after RXC heartbeat has elapsed (60 min)
- T3** Ditto; if 0.0 °C ⇒ frost alarm

**F2:**  
RXC receives no LONWORKS telegrams from the gateway

**Possible causes:**

- ⇒ Gateway has no power (power\_fail)
- ⇒ Bus interruption
- ⇒ Error in configuration of gateway
- ⇒ Gateway faulty

**Impact on the system:**

- T0** --
- T1** --
- T2** Invalid (327.7 °C) after RXC heartbeat has elapsed (60 min)  
*power\_fail gateway:*  
nvo\_temp\_p = 0.0 °C until room unit sends again (up to approx. 20 min.)  
Ohne SCPTmaxSendTime ⇒ T2 = last valid T2  
SCPTmaxSendTime < approx. 20 min ⇒ T2 = 0.0 °C (**frost alarm**)  
SCPTmaxSendTime > approx. 30 min ⇒ T2 = last valid T2
- T3** Ditto; at 0.0 °C ⇒ **frost alarm**

**F10:**  
**Power\_up / Power\_fail**  
**system**

***Impact on the system:***

**T0**

--

**T1**

All temperatures = 0.0 °C after Power\_fail / Power\_up.  
Room unit sends current temperature after about 20 to 30 minutes.

**T2**

RXC polls the gateway (0.0 °C) and sends value to the system.

**T3**

**Frost alarm** (0.0 °C). This state continues until all EnOcean room units have transmitted a valid temperature. This takes about 20 to 30 min, but may take longer than an hour should short breakdowns occur.  
If a room unit does not send (e.g. exhausted), frost alarm is maintained until that room unit sends as well.

With each simultaneous power failure of the RXC and the gateway, the system triggers frost alarm for 20 to 30 minutes. The same applies to power-up.

## Mounting

---

The devices are supplied in an operational status.

Installation is made by means of anchors and screws (not included) to the smooth wall surface, or by means of screws to an installation socket .

For operation a separate external 868 MHz receiving antenna is required (included in delivery).

### Notes for the radio reception

- The antenna with magnet foot should be mounted on the center of a 180 mm x 180 mm metal plate (galvanized sheet steel).
- In rooms the antenna should be mounted 1 m below the ceiling.
- The antenna should be vertically aligned downwards.
- Minimal distance to the wall: 90 mm.
- Distance to other transmitters (e.g. GSM / DECT/ wireless LAN / EnOcean etc.): min. 2 m.
- The antenna cable shall be routed in an electric conduit.
- Avoid crushing of the antenna cable.  
The minimal bend radius of the cable is 50mm.
- As for the cable installation, avoid the use of an active pull-up device, otherwise the sheathing or on the connectors may be damaged.

For details on positioning of the EnOcean room units, refer to data sheet CM2N1660.

## Commissioning

---

Wireless room units are sending time or event controlled telegrams to the gateway. The gateway verifies the incoming telegrams and outputs them directly via its LONWORKS interface.

Each telegram allows a precise allocation and consists of the format: type of the telegram, data, sender ID (32bit).

### EnOcean connection

In order to assure a correct evaluation of the measuring values by the gateway, it is necessary to have the devices learned-in by the gateway. This is done automatically by means of a "learn button" at the room unit (or manually by input of the 32bit sensor ID) and a special "learning" procedure between room unit and gateway.

For details, refer to the data sheet of the EnOcean room units, CM2N1660.

### LonWorks commissioning

In order to press the service pin, the lid must be opened.

## Disposal

---



The device is classified as waste electronic equipment in terms of the European Directive 2002/96/EC (WEEE) and should not be disposed of as unsorted municipal waste.

The relevant national legal rules are to be adhered to.

Regarding disposal, use the systems setup for collecting electronic waste.

Observe all local and applicable laws.

## Technical data

General device data	Operating voltage	DC 15...24 V AC 24 V +/- 10%	
	Power consumption	0.5W / 0.82VA	
	Interface	LONWORKS Transceiver FTT, free topology	
	Antenna connector	FME female	
	Antenna (included in delivery)	External antenna with magnetic stand	
	Terminals	Screw terminals max. 1,5 mm <sup>2</sup>	
	Cable entry	M20 for 1 cable max. D = 8 mm or 2 cables max. D = 7 mm	
	Mounting	Wall mounting	
	Housing protection	Protection	IP42 to EN60529
Ambient conditions	Temperature	-20...60 °C	
	Humidity	max. 70 % r.h. non-condensing	
CE conformity	Electromagnetic Compatibility	89/336/EEC	
	Radio and Telecommunications Terminal Equipment Directive	R&TTE 1999/5/EC	
	RoHS	Reduction of hazardous substances	
	2002/95/EC	2002/95/EC	
Standards	Electromagnetic compatibility		
	Emission	EN 61000-6-2	
	Immunity	EN 61000-6-3	
	Telecommunications	ETSI EN 301 4893 V.1.4.1	
	Home and building electronic systems (HBES)	EN 50090-2-2	
	Registration for radio operation	EC countries and CH	
Enclosure	Material	ABS	
	Color	white, similar to RAL9010	
Weight	Without / with packaging	173 g / 248 g	

## Connection terminals

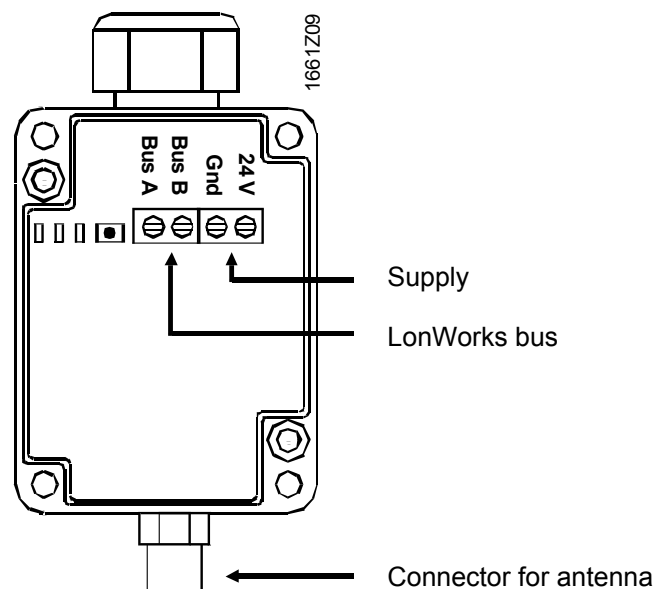

# Dimensions

Dimensions in mm

